

Varenummer: 2301044053  
 Beskrivelse: E+G Håndsving  
 MT.50-AT

## Mål

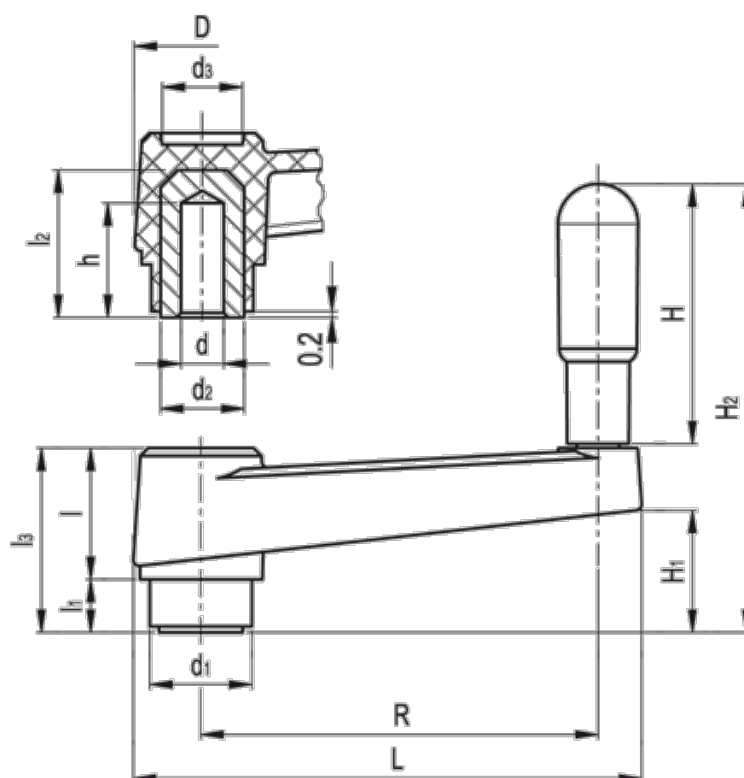

D	= 23	H2	= 66
d1	= 18.0	l	= 21
d2	= 15	L	= 69
d3	= 13	l1	= 9
d H7	= 6	l2	= 23
H	= 35	l3	= 30
h	= 18	R	= 50
H1	= 20.5	Vægt (g)	= 45